

TOWN OF DERRY, NH

QUOTE/BID LIST

B15-146 Precast Panels

Company Name	Quote/Bid	Unit Price
Concrete Systems, Inc.	\$20,670	\$212/LF
American Concrete Industries	\$24,940	\$249.40/LF
Phoenix Precast	\$26,880	\$280/LF

Budget line 20303200 720000

Bid Recipient Concrete Systems, Inc.

Department Head Signature  Date 12/21/15



Town of Derry, New Hampshire

REQUEST FOR BID

(# B15-146)

November 16, 2015

Request for Bids – Precast Concrete Bunker Panels

The Town of Derry is requesting sealed bids for precast concrete bunker panels. Proposals will be accepted at the Town of Derry Municipal Center, 14 Manning Street, Derry NH 03038 **until 4 PM on Wednesday, December 2, 2015.**

Bid Specifications: Furnish twelve (12) 4 or 5 foot wide base 'L' style free standing precast concrete bunker panels 8 foot long x 10' 6" high. All submissions shall include detailed specifications of dimensions. The panels will be used in a municipal recycling center. **Bidders may furnish alternate designs, provided they are properly engineered and meet the size requirements from above.**



This price shall include delivery to the Derry Transfer Station, 53 Transfer Lane, Derry NH.

Bids must be delivered to the Town of Derry in a sealed envelope clearly marked

"Precast Concrete Bunker Panels"

The Town of Derry may reject any or all of the bids on any basis and without disclosure of a reason, as in compliance with Administrative Regulation #15 governing purchasing.

Furnish and Install twelve (12) precast concrete bunker panels per specifications

Price Twenty thousand, six hundred, seventy Dollars and 00/100 Cents - \$ 20,670.00

Company Name: Concrete Systems, Inc.

Address: 9 Commercial Street
Hudson, NH 03051

Email Address tgarcia@csigroup.com

Signature [Handwritten Signature]

* Please see our attached proposal PR 25094, dated 12/1/15 for our proposed design.



Town of Derry, New Hampshire

REQUEST FOR BID

(# B15-146)

November 16, 2015

Request for Bids – Precast Concrete Bunker Panels

The Town of Derry is requesting sealed bids for precast concrete bunker panels. Proposals will be accepted at the Town of Derry Municipal Center, 14 Manning Street, Derry NH 03038 until 4 PM on Wednesday, December 2, 2015.

Bid Specifications: Furnish twelve (12) 4 or 5 foot wide base 'L' style free standing precast concrete bunker panels 8 foot long x 10' 6" high. All submissions shall include detailed specifications of dimensions. The panels will be used in a municipal recycling center. **Bidders may furnish alternate designs, provided they are properly engineered and meet the size requirements from above.**

This price shall include delivery to the Derry Transfer Station, 53 Transfer Lane, Derry NH.

Bids must be delivered to the Town of Derry in a sealed envelope clearly marked

"Precast Concrete Bunker Panels"

The Town of Derry may reject any or all of the bids on any basis and without disclosure of a reason, as in compliance with Administrative Regulation #15 governing purchasing.

Furnish and Install ~~twelve (12)~~ ^{20-10'10" TALL X 5' WIDE (SEE PLAN)} precast concrete bunker panels per specifications

Price Twenty four Thousand Dollars and 0 Cents - \$ 24,940
Nine hundred forty

Company Name: AMERICAN CONCRETE INDUSTRIES

Address: 982 MINOT AVE
AUBURN, ME. 04210

Email Address jason @ american concrete. com

Signature Jason Spunju

SITE MUST BE PREPARED prior to DELIVERY of product.

John A. ... w/ ...

11/11/12 ...

Request for Bid - Precast Concrete Tanker Panels

The Town of ... is seeking proposals for the supply and installation of precast concrete tanker panels. The project is located at ... The estimated quantity is ...

Proposals should be submitted to the Town of ... at the following address: ...

For more information, please contact the Town of ... at ...

Precast Concrete Tanker Panels

The Town of ... is seeking proposals for the supply and installation of precast concrete tanker panels. The project is located at ... The estimated quantity is ...

80-1010 ...

...
...
...

...

...

...

...

...

...

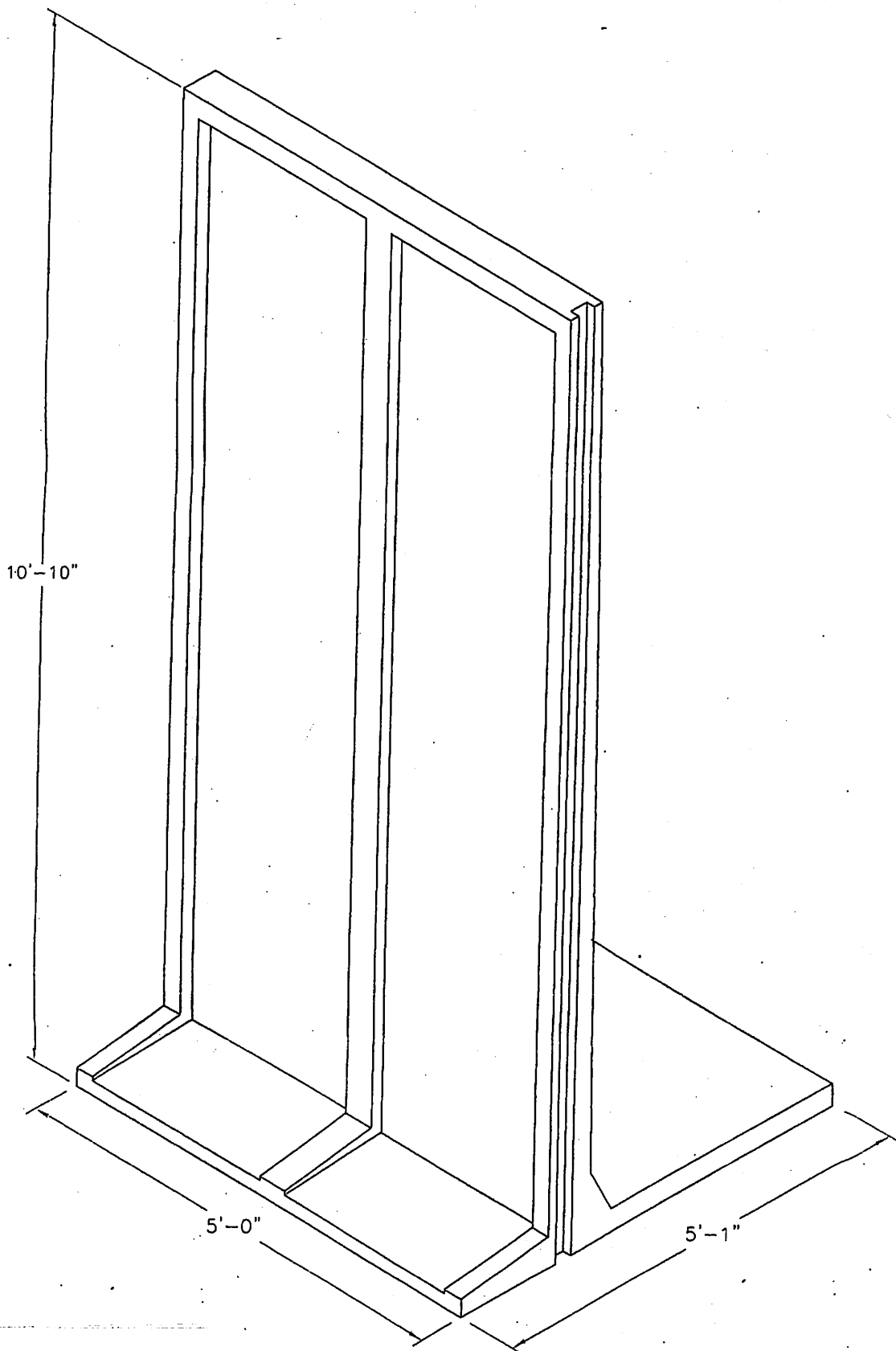

ISOMETRIC VIEW

RWLS-10	10' L-Shaped Retaining Wall
FILE NAME: 332TRGRWLS-10-ISO.DWG	
ISSUE DATE: January, 2005	

NOTES:

1. Concrete Minimum Compressive Strength 5,000 psi @ 28 days With Steel Reinforcement
2. Tongue and Groove Joints are Bolted Together
3. Center Sections are Available

Manufactured by:
Superior Concrete
Auburn, ME 207-784-9144

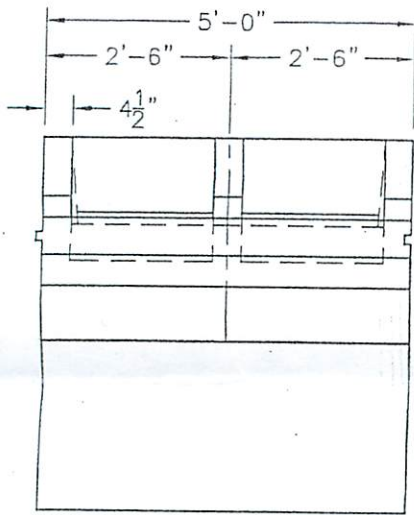

PLAN VIEW

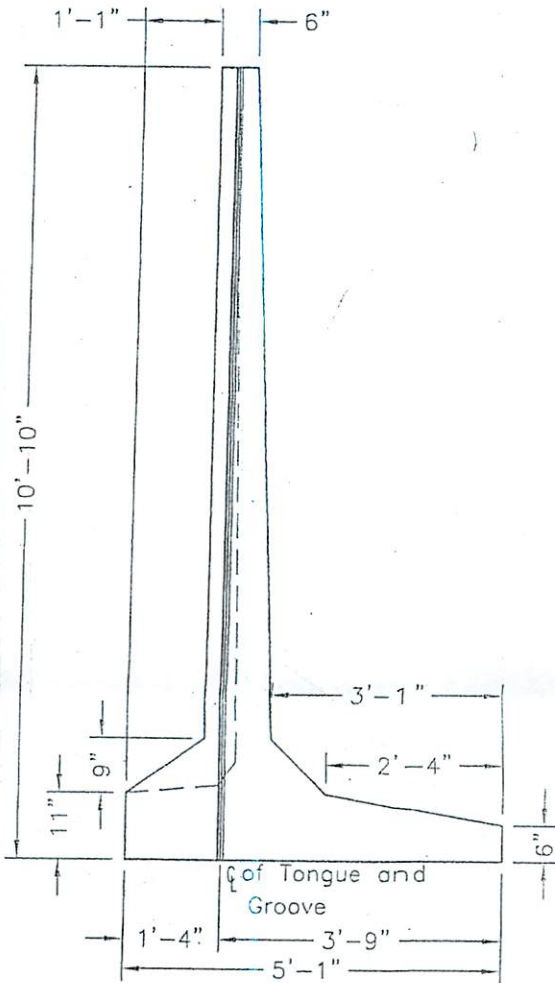

END VIEW

Scale: 3/8" = 1'-0"

RWLS-10

FILE NAME: 332TRGRWLS-10.DWG

ISSUE DATE: January, 2005

10' L-Shaped
Retaining Wall

Copyright © 2005 Superior Concrete



Town of Derry, New Hampshire

REQUEST FOR BID
November 16, 2015

(# B15-146)

Request for Bids – Precast Concrete Bunker Panels

The Town of Derry is requesting sealed bids for precast concrete bunker panels. Proposals will be accepted at the Town of Derry Municipal Center, 14 Manning Street, Derry NH 03038 until 4 PM on Wednesday, December 2, 2015.

Bid Specifications: Furnish twelve (12) 4 or 5 foot wide base 'L' style free standing precast concrete bunker panels 8 foot long x 10' 6" high. All submissions shall include detailed specifications of dimensions. The panels will be used in a municipal recycling center. **Bidders may furnish alternate designs, provided they are properly engineered and meet the size requirements from above.**

This price shall include delivery to the Derry Transfer Station, 53 Transfer Lane, Derry NH.

Bids must be delivered to the Town of Derry in a sealed envelope clearly marked

"Precast Concrete Bunker Panels"

The Town of Derry may reject any or all of the bids on any basis and without disclosure of a reason, as in compliance with Administrative Regulation #15 governing purchasing.

Furnish and install twelve (12) precast concrete bunker panels per specifications

Price TWENTY SIX THOUSAND EIGHT HUNDRED EIGHTY Dollars and — Cents - \$ 26,880.00

Company Name: PHOENIX PRECAST

Address: 77 REGIONAL DRIVE
CONCORD, NH 03301

Email Address: rdore@phoenixprecast.com

Signature: 

OFFICE OF THE DIRECTOR OF THE BUREAU OF LAND MANAGEMENT
DENVER, COLORADO

MEMORANDUM FOR THE DIRECTOR

Re: [Illegible text]

1. [Illegible text]

2. [Illegible text]

3. [Illegible text]

Very truly yours,
[Illegible signature]

Special Agent in Charge
[Illegible signature]

Special Agent in Charge
[Illegible signature]

General Notes:

1. Concrete: f'c = 5,000 psi @ 28 Days Minimum
2. Reinforcing Steel: ASTM-A615 Grade 60 Black Deformed Bars

Est Weight: 13,800 Lbs

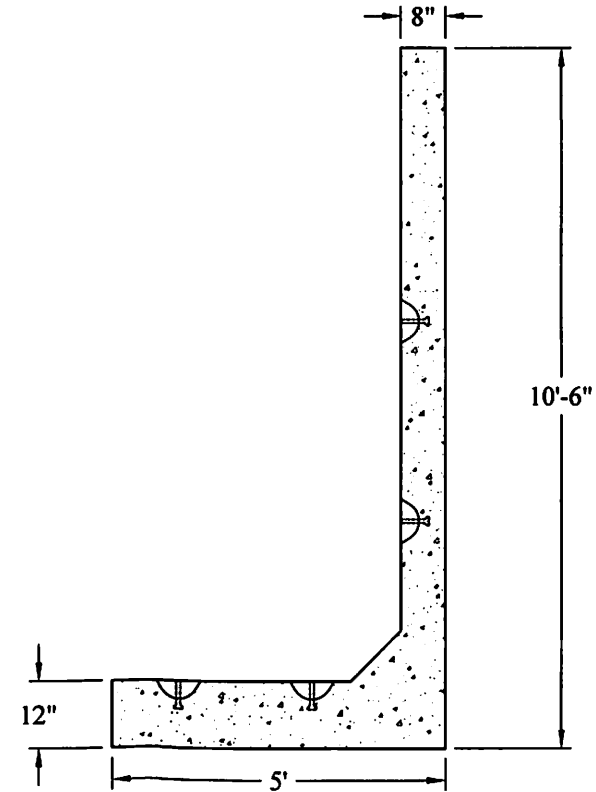
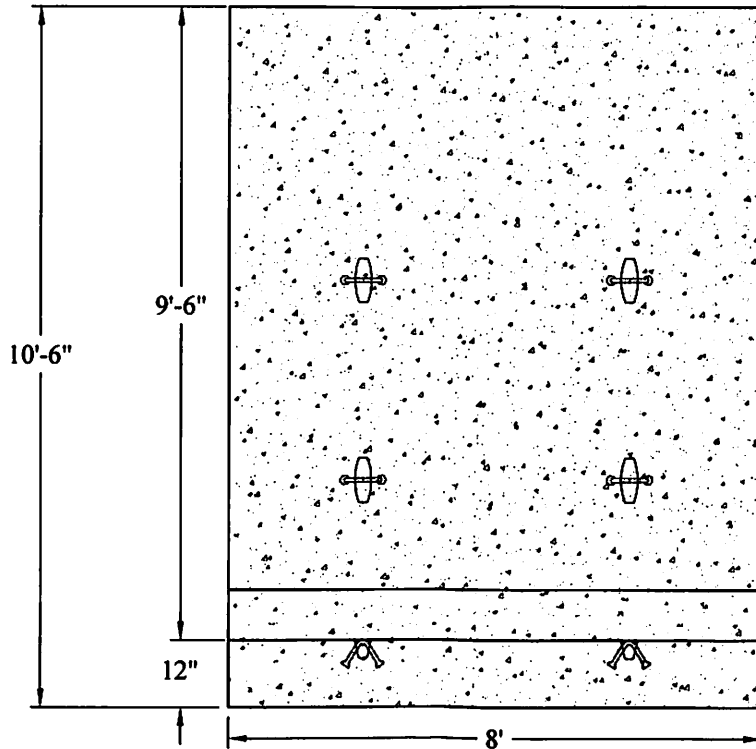
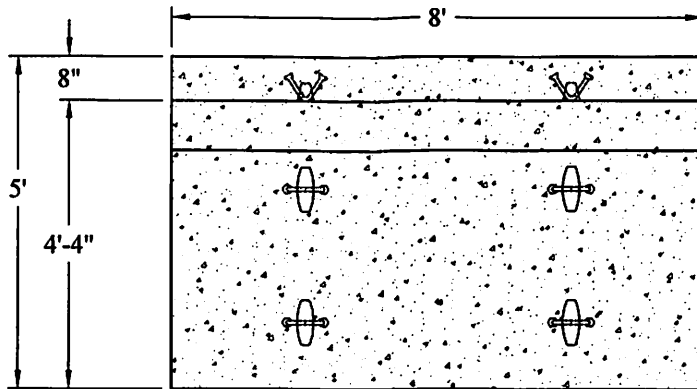

Phoenix Precast Products

Phoenix Precast Products

Customer:	Town of Derry NH	Job No.	-	Date	11/17/15	Drawn By:	SMM
Location:	Transfer Station, Derry NH	Custom No.	C-5164	Rev:	1	App'd:	
						Phoenix Precast Products	5' x 8' x 10'-6" Bunker Panels

77 Regional Drive

Concord, NH 03301